



ZERO defect

SMART TABLE
SINGLE SHEET CONFORMITY VALIDATION AND QUALITY CHECKING

**INSPECTION AND
TRACEABILITY SOLUTIONS**

is
in-core
systèmes

CONFORMITY VALIDATION AND QUALITYCHECKING BY SAMPLING FOR CONVERTING PROCESSES

Optical quality control and measurement equipment for flat products of various converting process such as high security paper & printing, hologram, fabrics or printed electronics

Smart table

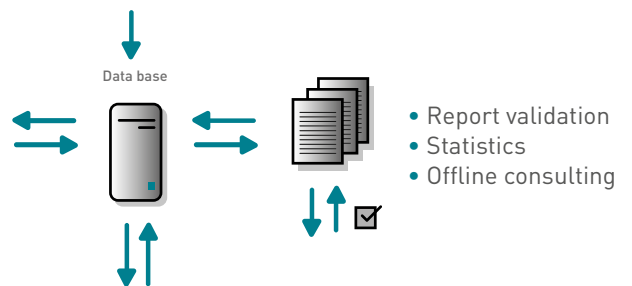
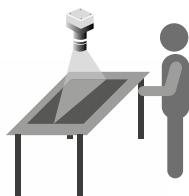

- Report validation
- Statistics
- Offline consulting

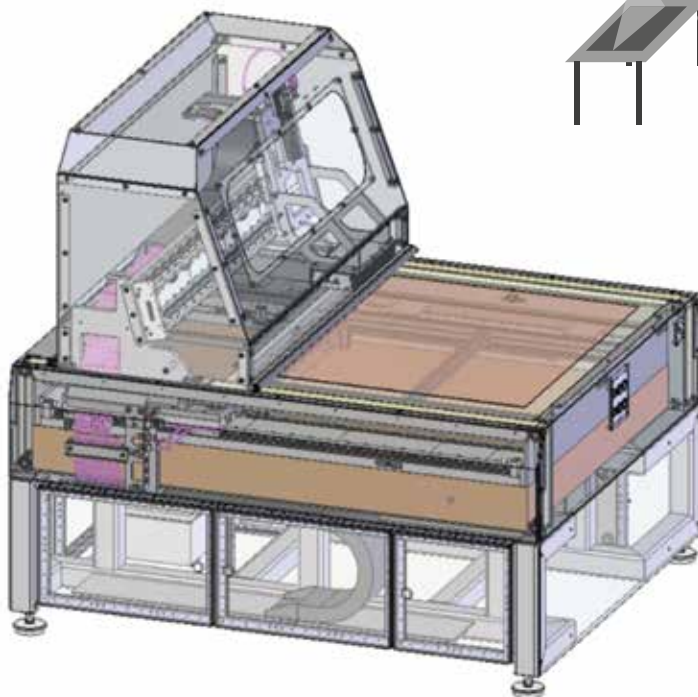

INSPECTION BASED ON :

- Reference image
- PDF model with automatic adjustment according to the inspection resolution

TYPE OF CONTROLS

- Registration control
- Dimensional control (positions, measurements, ...)
- Aspect control
- Multi spectral inspection of different features

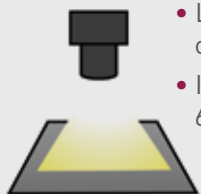

- Linescan camera to acquire a continuous image of the product
- Image acquisition at standard 600 DPI and up to 2400 DPI



UV



IR



- Multispectral acquisition conditions customizable according to type of product
- IR transmission lightning
- Top and/or bottom R G B, IR and UV lightning



- Encoder for image acquisition and mechanics synchronization
- Glass plate, 1mx1m
- 2 high precision Linear axes X, y with optional Z compensation to motorize the scan of the sheet in approximately 1 min



PACKAGING



PRINTED ELECTRONICS



SECURITY PRINTING

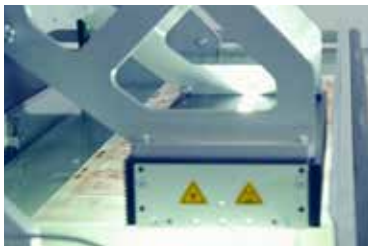

HOLOGRAM

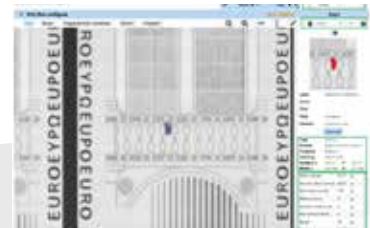
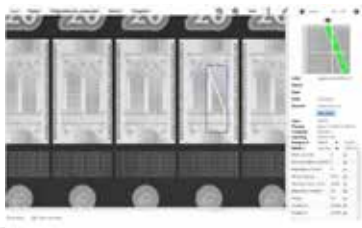

Inspection and measurement software

- One sheet' side and transmission inspection: manage scanning, inspection and learning, including visualization tools as zoom and defect browsing



Inspection algorithms

- Learning procedure allows to build open "inspection scenario"
- The learning mask can be downloaded in .dxf or .pdf format and compared to the selected ROI area.
- Inspection: all features can be inspected in terms of absolute and relative position, size, quality (e.g. over print excess of ink, under print lack of ink, ...)
- Post processing analyses of all inspected sheets "Report Manager". The full report will be stored in database and it can be browsed with the Report software

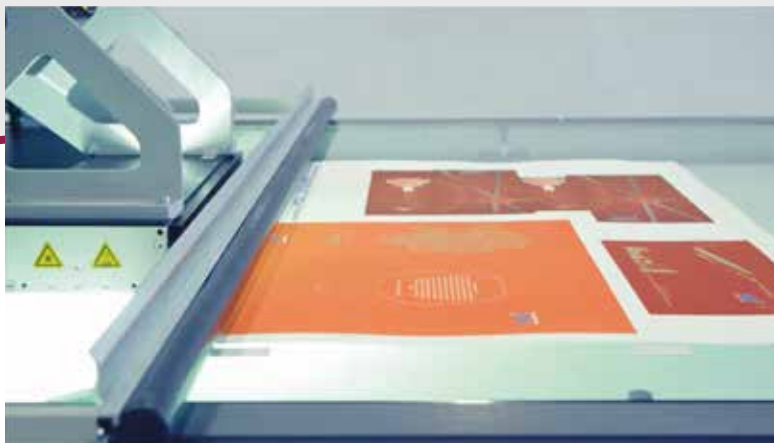

OUR RANGE OF SERVICES

SYSTEM SPECIFICATIONS

- Evaluation of your needs
- Feasibility study
- Customization
- Definition of project
- Flexibility/adaptation to future needs

GOLD SUPPORT

- Telephone hotline
- Technicians
- Remote access
- Application consulting

COMMISSIONING

- Installation
- Training
- Start-up

SERVICES

- Onsite repairs
- Spare parts
- Preventive maintenance



In-Core Système France
10 rue Ampère - 69680 Chassieu
Tél : +33 (0)4 69 84 16 68
www.incore-systemes.com

